

# SH 449P

## Extra Long Arm Full-Motion TV Wall Mount

For most 23"-65" TVs



Enjoy more viewing positions with a long-reach arm



Dimensions (mm)

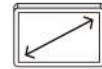
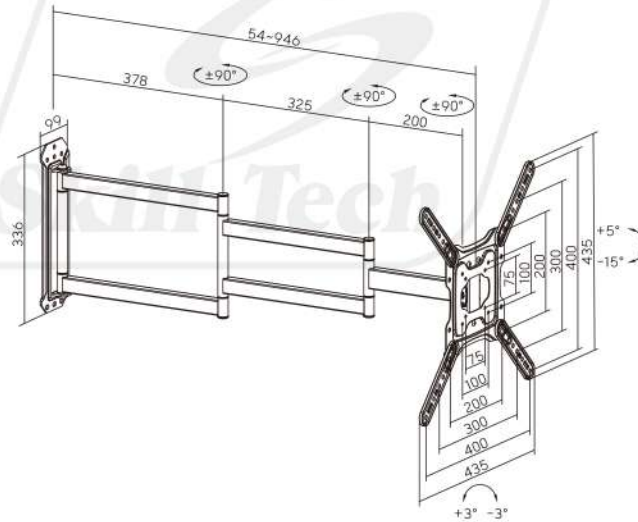

Screen Size  
**23"-65"**

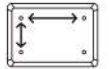

VESA Compatible  
**Max. 400x400**



Weight Capacity  
**35kg/77lbs**



Screen Level  
**+3° - -3°**

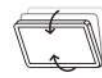

Tilt Range  
**+5° - -15°**

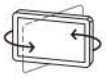

Swivel Range  
**+90° - -90°**

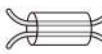

Cable Management



Curved TV

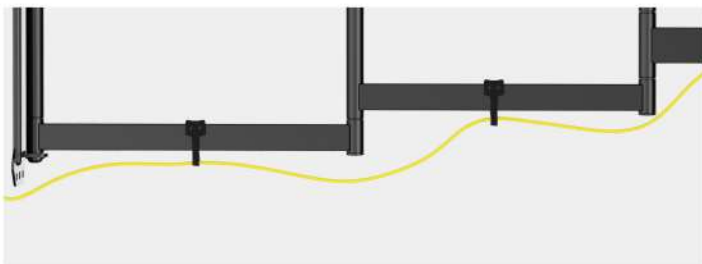

**Cable Management**  
hook and loop fasteners are included for a clean look

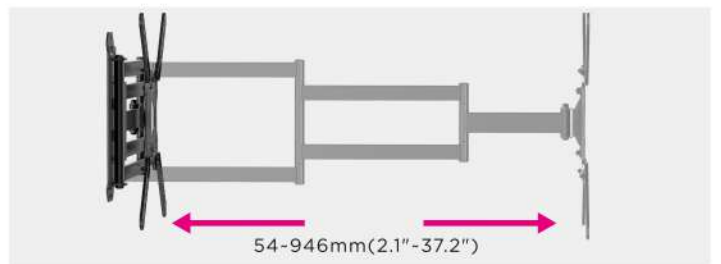

**Extra Long Extension Arm**  
covers more viewing positions